

When weather forecasters decide the storm might reach land within 2 days, they issue a Hurricane **Watch**.

A Watch tells people who live or work near the coast that the hurricane over the ocean might reach land. The National Weather Service will tell you what is happening. Listen to the radio or television.

## Hurricane Warning

When the National Weather Service puts out a **Warning**, it means a hurricane is likely to reach land near you with winds more than 73 miles an hour! That's hard enough to blow down trees and other big objects that could hit you or your home. Ouch!

A Warning also means dangerous high water and very rough seas are expected. You definitely need to get off your boat and get to safety.

# Get out when you are told.

When the hurricane hits, the sea may rise as high as 25 feet above normal high tide! That is taller than six kids standing on each other's shoulders!

This extreme high tide is called the storm surge. The surge sinks boats, knocks down piers and floods houses. Most people who die during a hurricane drown because of inland flooding, not wind.

If you live near the shore, plan to go inland where it's safer.

In a big hurricane, the speed of the winds may be more than 150 miles an hour! Trees and houses are blown down. Windows in buildings are blown out. It rains hard. There may be flooding hundreds of miles from the coast as heavy rain falls. Watch out for flying debris.



# Before the Storm Comes . . .

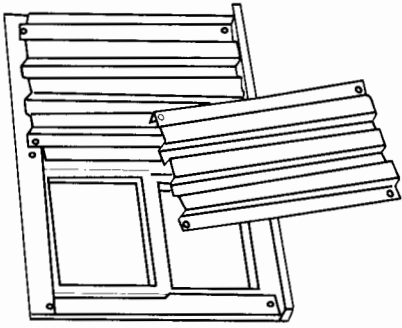
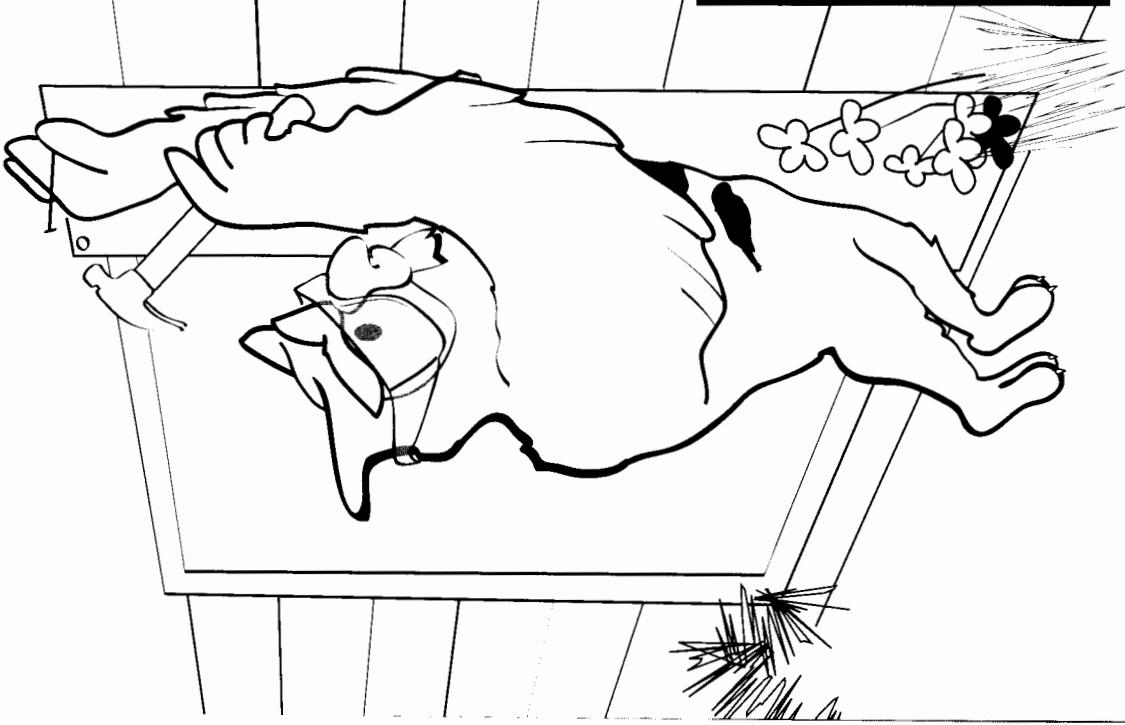

Put boards or storm shutters over windows. Do NOT tape the windows. Taping just leaves gunk on your windows, it doesn't protect them.

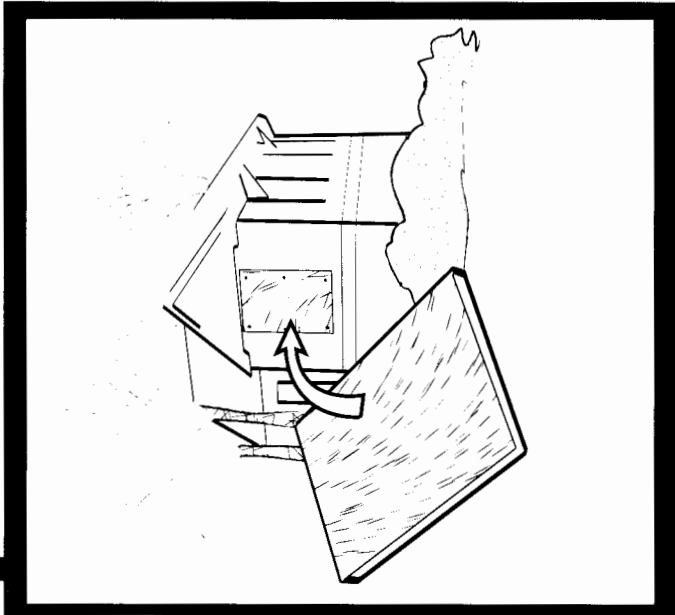

Pick up all the small things laying around your yard, like toys, tools and flower pots and bring them inside. The wind could pick them up and send them slamming into windows, cars or you!



If you're not close to shore, you may plan to stay in your home to ride out the storm. Clean drains and prepare for flooding.

# When the Hurricane Comes . . .

Stay indoors. Trees could fall on you. You could be blown over. Flying boards, limbs or garbage could crash into you. A live electric wire could fall on you. Intense rain may cause flooding. Often heavy rain and flooding are more dangerous than wind.

Beware of the eye of the hurricane. A hurricane is a big doughnut of wind with a calm section at the middle. That calm section is called the eye of the hurricane.

- The whole hurricane could be 300 miles across. The calm center may last from a few minutes to an hour or more.
- The sun may come out and you might think the storm is over. But it isn't. As the hurricane moves, winds will blow just as hard, but from the opposite direction.

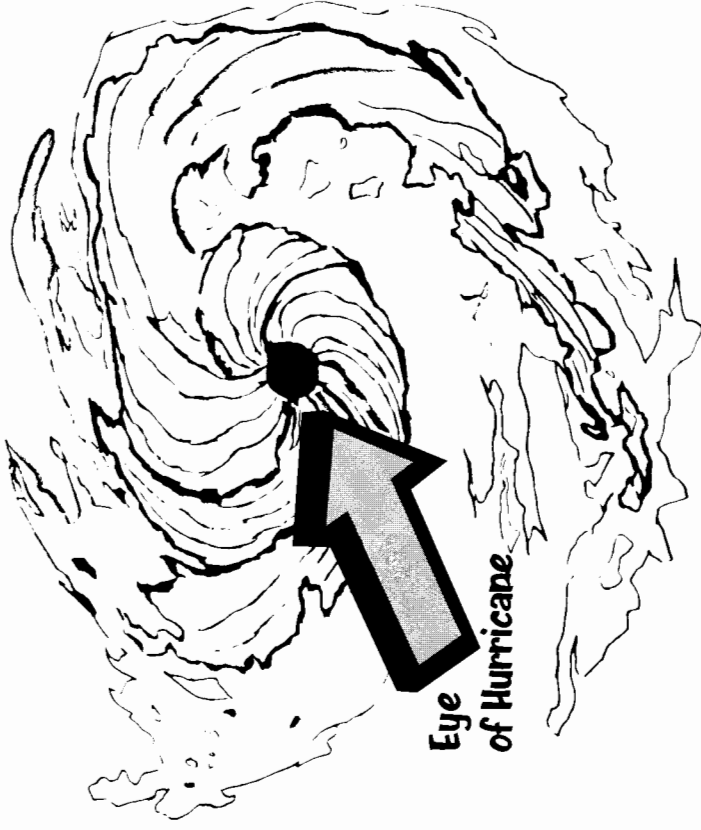

Get a flashlight and a radio that run on batteries in case you lose electricity.

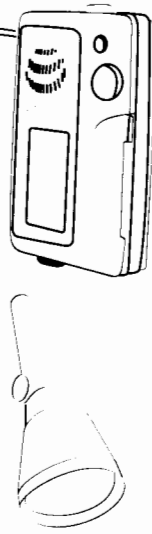

## Hurricanes and

**Tropical Storms can kill. Don't be caught by one!**

Save and clean six 2-liter soda bottles or a large water container (as shown) for each family member. When a storm warning is announced, fill up the bottles.

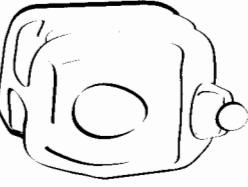

Water pipes may break. Also, water from faucets may not be safe to drink for a while.

**Get out of its way.  
Go inland. Do it  
immediately!**

# Hurricane Quiz

Fill in the blank with the correct words. Use these words:

watch eye radio flooding  
hurricanes moving warning air  
inland high tides oceans

1. The \_\_\_\_\_ that surrounds our planet weighs five quadrillion tons.
2. Air is \_\_\_\_\_ all the time. It swirls, blows, sinks and rises.
3. Air moves over warm \_\_\_\_\_ and picks up lots of moisture.
4. In summer and early fall, \_\_\_\_\_ form when air masses pick up lots of moisture.
5. Hurricanes cause \_\_\_\_\_ and \_\_\_\_\_.
6. A hurricane \_\_\_\_\_ tells people a hurricane may reach land within 2 days.
7. A hurricane \_\_\_\_\_ means a hurricane is expected within 24 hours and winds could reach up to 74 mph.
8. NOAA Weather \_\_\_\_\_ warns people about hurricanes.
9. If you live near the ocean, go \_\_\_\_\_ where it is safe.
10. The center of a hurricane is called the \_\_\_\_\_.

Answers on page 41

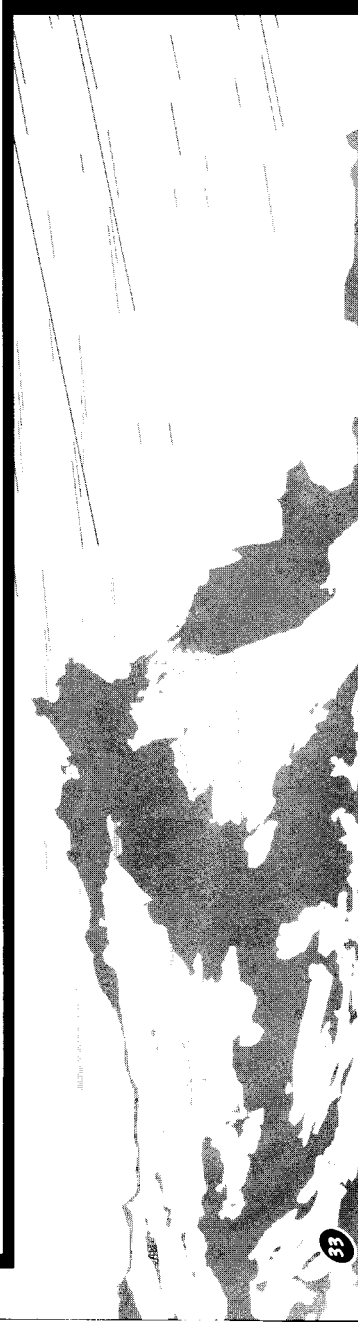

List 3 things you can do to prepare for a hurricane.

\_\_\_\_\_

\_\_\_\_\_

\_\_\_\_\_

Circle T (true) or F (false) for each sentence below.

- |   |   |  |
|---|---|--|
| T | F | 1. High wind is called a storm surge.  |
| T | F | 2. NOAA Weather Radio stations warn people about hurricanes.                                       |
| T | F | 3. Hurricanes usually appear suddenly and surprise everyone.                                       |
| T | F | 4. When a hurricane is expected to reach land in 2 days forecasters issue a Hurricane Warning.     |
| T | F | 5. Hurricane Hunter airplanes fly into a storm to get information about the hurricane.             |
| T | F | 6. Hurricane winds can reach 350 mph.  |
| T | F | 7. Hurricanes cause rain, high tides and flooding.   |
| T | F | 8. During a hurricane, stay under a tree.  |
| T | F | 9. Put duct tape on your windows if a hurricane is coming.   |
| T | F | 10. It is a good idea to have a flash light, radio and extra batteries if a hurricane is expected. |

# Answers

## crossword puzzle (pgs 37-38)

### Answers: (Across)

4. Electricity, 6. Wind Chill, 7. Summer, 8. Floods, 14. Thunder, 15. Weather, 16. Hail, 17. Funnel

### Answers: (Down)

1. Forecasts, 2. Radio, 3. Eye, 5. Tornado, 7. Snowstorms, 9. Lightning, 10. Surge, 11. Shortest, 12. Warning, 13. Hurricane

## true & false (pg 36)

1. F-lightning, 2. T, 3. F-Flooding, 4. F, 5. F-anywhere, 6. F, 7. T, 8. F, 9. T, 10. F

## fill in the blanks (pg 34)

1. Tornado, 2. tornado, 3. lightning, 4. winter storm, 5. flash flood, 6. hurricane, 7. hurricane, 8. tornado, 9. hurricane, 10. tornado.

## flash flood quiz (pg 32)

1. roads, 2. flash flood, 3. ground, 4. streams, 5. car, 6. bridges -- 1. T, 2. F, 3. T, 4. T, 5. F, 6. F, 7. F, 8. T, 9. F, 10. T

## tornado quiz (pg 31)

1. tornado, 2. funnel and top, 3. black clouds, 4. watch, 5. warning, 6. train, 7. ditch, 8. basement, 9. hail, 10. bathroom, 11. windows, 12. mobile home, 13. sky, 14. radio -- 1. T, 2. F, 3. T, 4. T, 5. T, 6. F, 7. F, 8. T, 9. T, 10. F

## winter storm quiz (pg 30)

1. watch, 2. warning, 3. kitty litter, 4. antenna, 5. carbon monoxide, 6. layers, 7. mittens, 8. winter, 9. wind chill, 10. snowdrift -- 1. T, 2. F, 3. T, 4. F, 5. F, 6. T, 7. T, 8. T, 9. F, 10. F

## lightning quiz (pg 29)

1. die, 2. telephone, 3. thunder, 4. explode, 5. tallest, 6. shortest, 7. electricity, 8. tree, 9. fire, 10. water -- 1. F, 2. T, 3. F, 4. T, 5. F, 6. F, 7. T, 8. F, 9. F, 10. T

## hurricane quiz (pg 33)

1. air, 2. moving, 3. oceans, 4. hurricanes, 5. high tides and flooding, 6. watch, 7. warning, 8. radio, 9. inland, 10. eye -- 1. F, 2. T, 3. F, 4. F, 5. T, 6. F, 7. T, 8. F, 9. F, 10. T

## hazards (pg 35)

1. Tornado, 2. hurricane, 3. hurricane, lightning and tornado, 4. winter storm and lightning, 5. flash flood, 6. lightning, 7. hurricane, lightning, winter storm, and tornado, 8. hurricane, tornado, and winter storm, 9. hurricane, tornado, winter storm and flash flood, 10. tornado